

ASSEMBLY INSTRUCTIONS

PLANTAGEN®

Livorno
Matgrupp/Spisebordsett/Ruokapöytä/ruokasetti/Dining set



READ & SAVE BELOW INSTRUCTIONS BEFORE ASSEMBLY

1. PLEASE SEPARATE AND IDENTIFY ALL PARTS, MAKING SURE THAT YOU HAVE ALL OF THE PARTS LISTED.
2. TO AVOID ANY SCRATCHES DURING ASSEMBLY, PLEASE ASSEMBLE ON A SOFT MAT OR SIMILAR.
3. PLEASE ASSEMBLE STEP BY STEP AND FOLLOW THE INSTRUCTIONS.
4. WASHERS MUST BE USED.
5. WHILE EACH SCREW AND NUT IS PROPERLY FASTENED, DO NOT OVER FASTEN IT.
6. DO NOT COMPLETELY FASTEN EACH SCREW AND NUT UNTIL ALL THE SCREWS ARE PROPERLY FIXED.





Install all the relevant screws, but do not tighten them completely at the very beginning.
Tighten the screws fully one by one.

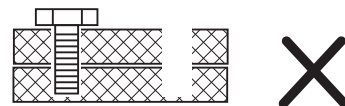

Don't tighten up the screw before you start next mounting during the installation.

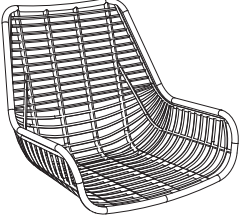
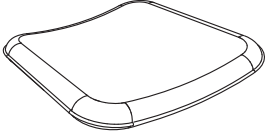
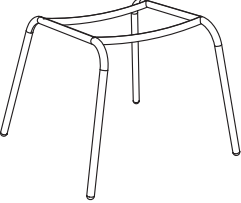

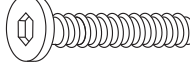
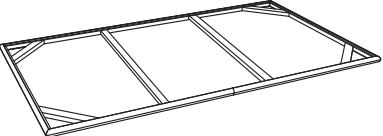
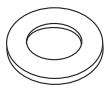
PARTS LIST

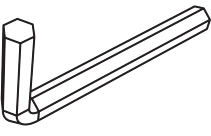
A		6x		F		6x
B		6x		G		20x
C		4x		H		24x
D		1x		I		44x
E		1x		J		1x

1

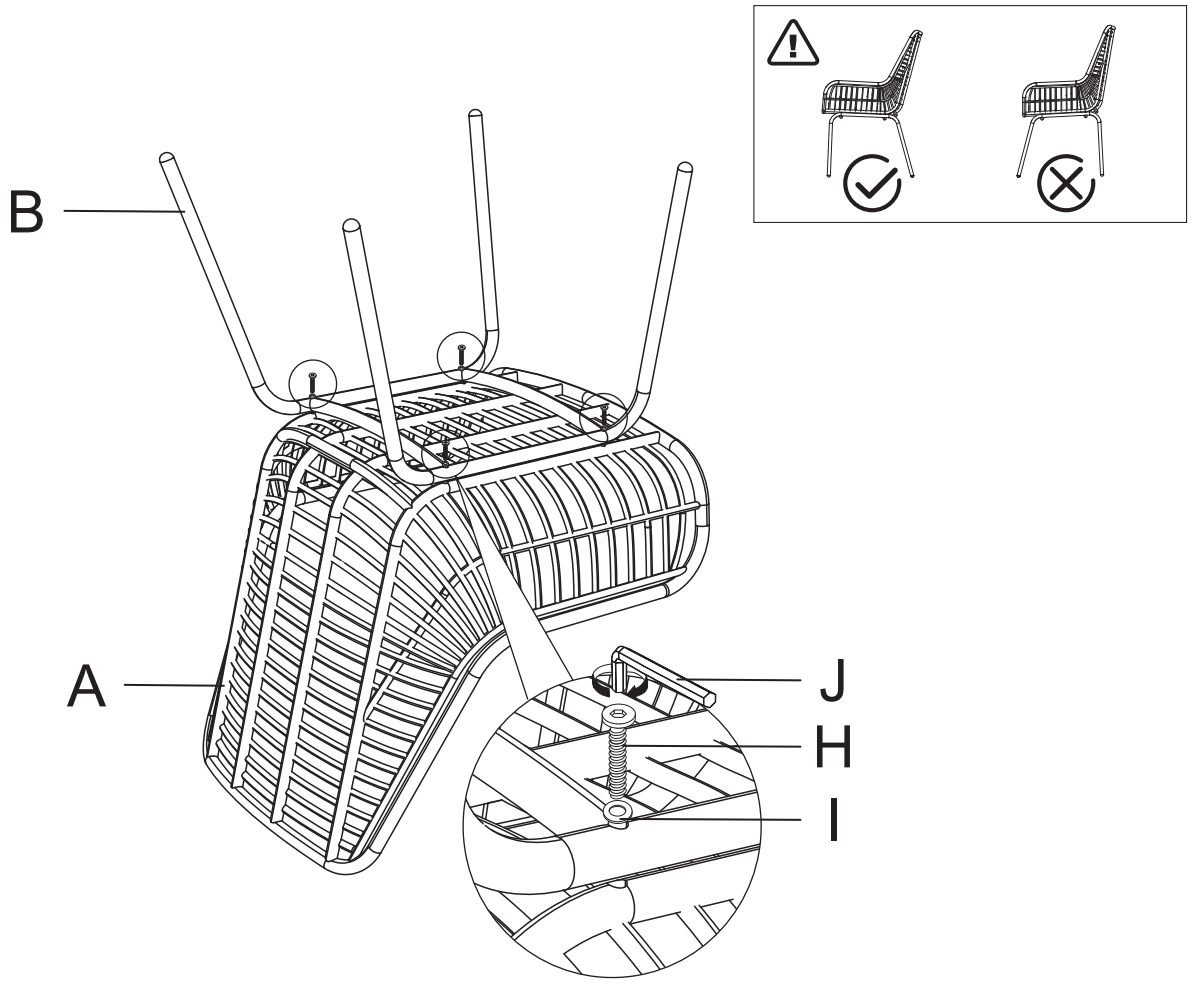

2

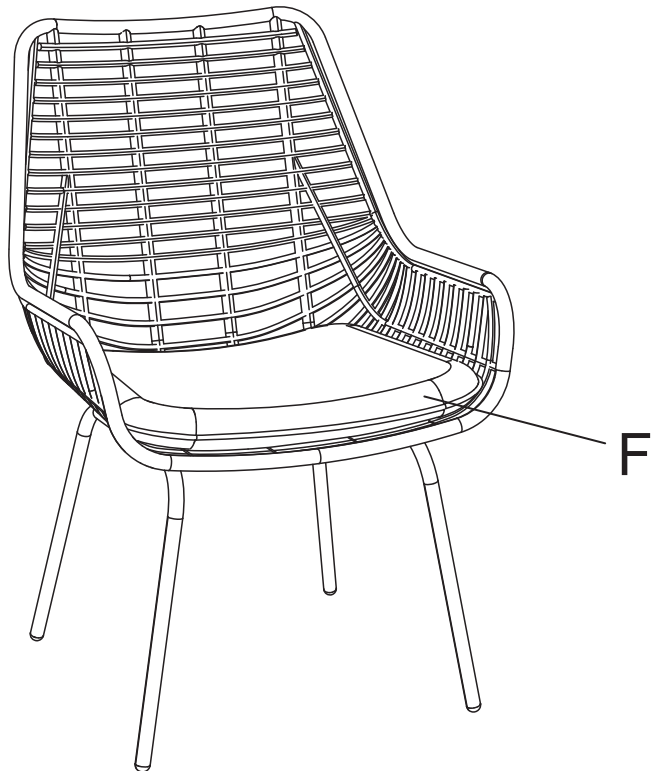

3

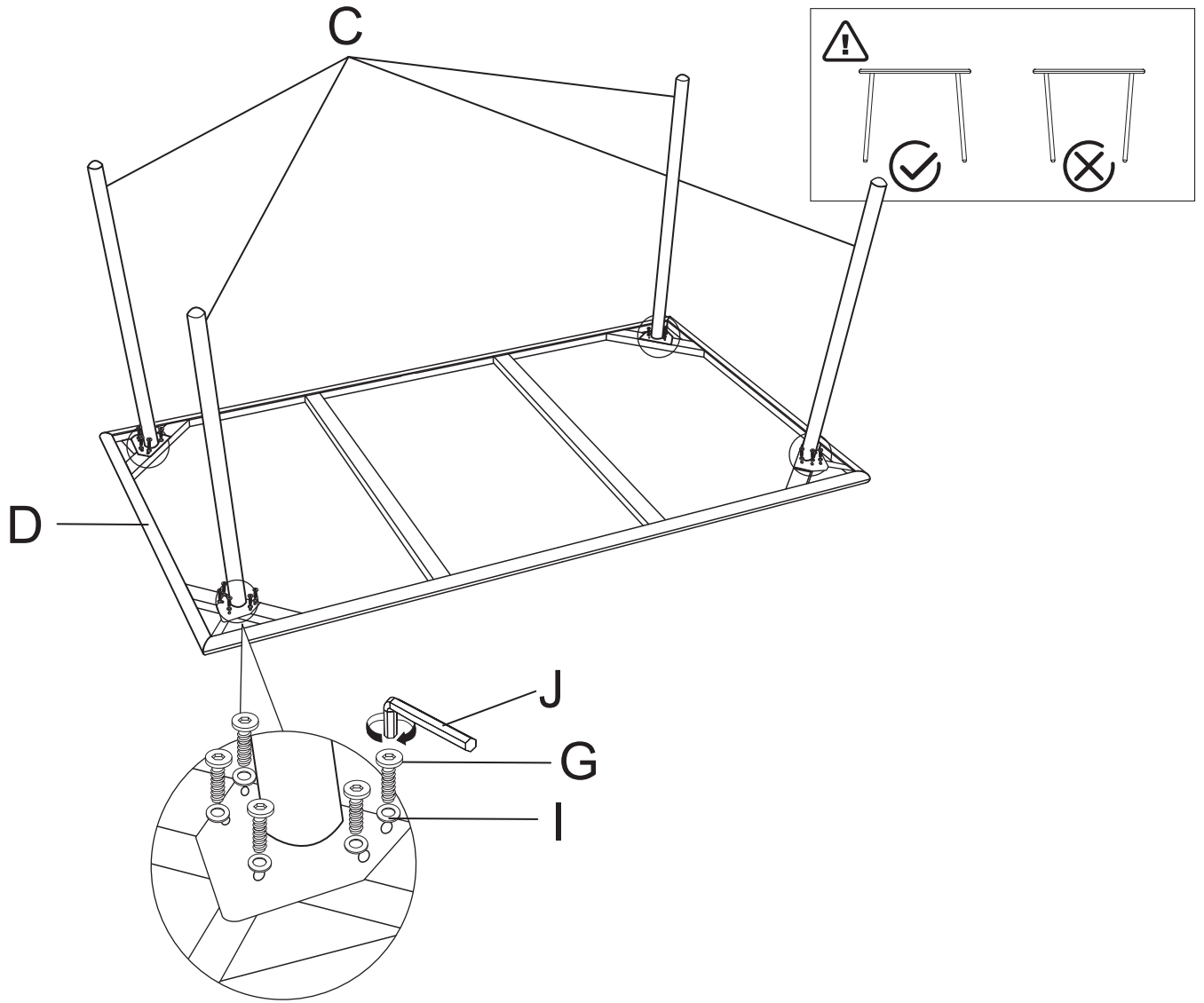

4

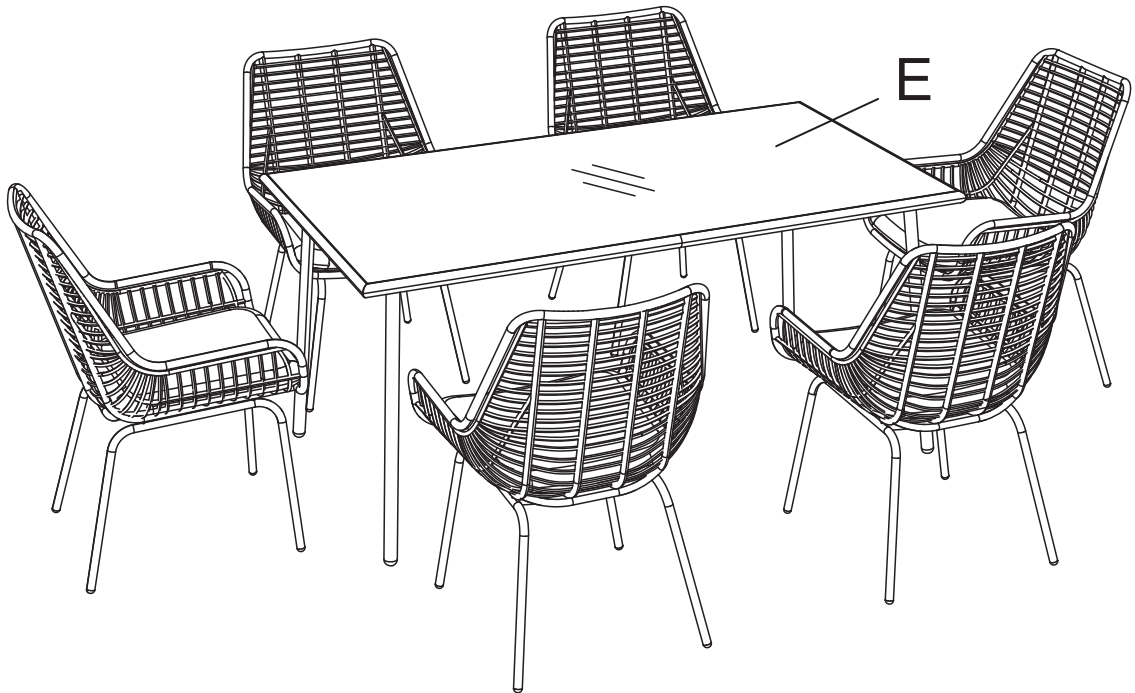

CARE AND CLEANING:

1. TO CLEAN,WIPE WITH A DAMP CLOTH.DO NOT USE BLEACH,ACID SOLVENTS OR ABRASIVE CLEANERS OR FRAME PARTS.
2. DURING VARYING WEATHER CONDITIONS AND WINTER PERIOD,WE STRONGLY RECOMMEND THAT IT IS STORED IN A DRY AREA WITH A SUITABLE COVER, BEFORE STORAGE PLEASE ENSURE IT IS CLEAN AND DRY.
3. IN THE EVENT OF BARE METAL SHOWING DUE TO SCRATCHES,IT IS RECOMMENDED TO TREAT WITH A RUST REPELLING VARNISH OR SIMILAR.
4. PERIODICALLY CHECK AND ENSURE THAT ALL THE SCREWS ARE COMPLETELY TIGHTENED.
5. A MATCHING FURNITURE COVER IS STRONGLY RECOMMENDED TO EXTEND THE USAGE LIFE-SPAN.